

UBT 12/7

Rechargeable AGM battery 7 Ah / 12 V

UBT: Powerful and reliable back-up storage

Salicru's **UBT** series batteries are extremely powerful and compact rechargeable lead-lead dioxide energy accumulators particularly suitable for UPSs and other security systems that require reliable and high-quality energy back-up.

Salicru's **UBT** battery range includes 7 Ah at 12 V.

The sulphuric acid electrolyte is absorbed by the separators and plates. And these in turn immobilised. They are designed using gas recombination technology which eliminates the need for the regular addition of water by controlling the evolution of hydrogen and oxygen during charging. The battery is completely sealed and watertight and therefore maintenance free, enabling it to be used in any position. If the battery is accidentally overcharged, resulting in the production of hydrogen and oxygen, a number of special one-way valves allow the gases to escape to avoid interior overpressure.



Applications:

Uninterruptible power supply systems (UPS), emergency lighting systems, signalling systems, communications and electrical equipment, broadcasting systems, lift automation panels, electronic cash registers, etc.

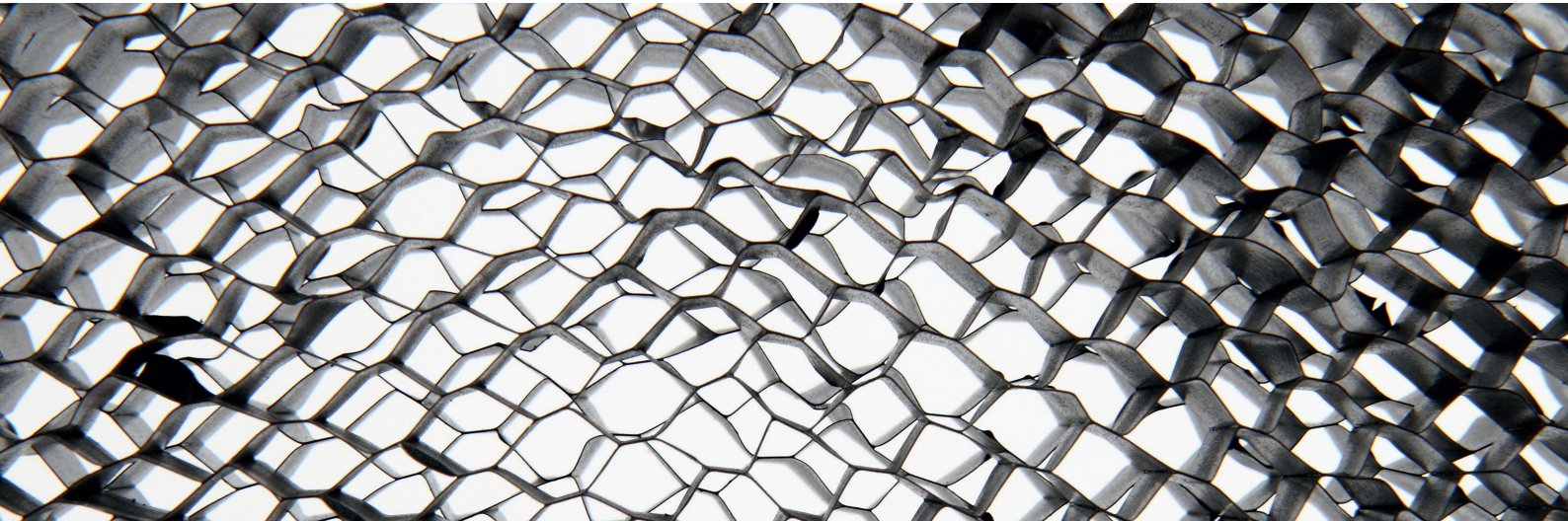

SALICRU

Performances

- AGM technology for efficient gas recombination of up to 99% and free of maintenance or adding water.
- No restrictions for air transport, compliance with IATA/ICAO Special Provision A67.
- Can be mounted in any position.
- Lead designed by computer with calcium/tin alloy rack for high energy density.
- Long service life in both float and cyclic applications.
- Maintenance-free.
- Low self-discharge



Battery compatibility vs series

	UBT 12/7
SPS Home	-
SPS One	•
SPS Soho+	•
SPS Advance T	•
SPS Advance R	-
SPS Advance RT2	•
SLC Twin PRO2 0-3 kVA	•
SLC Twin PRO2 4-20 kVA	•
SLC Twin RT2 0-3 kVA	•
SLC Twin RT2 4-10 kVA	•
SLC Cube3+	•
SLC Adapt / X	•

Battery construction

COMPONENT	RAW MATERIAL
Positive plate	Lead dioxide
Negative plate	Lead
Container	ABS
Lid	ABS
Safety valve	Rubber
Terminal	Copper
Separator	AGM
Electrolyte	Sulphuric acid

Dimensions

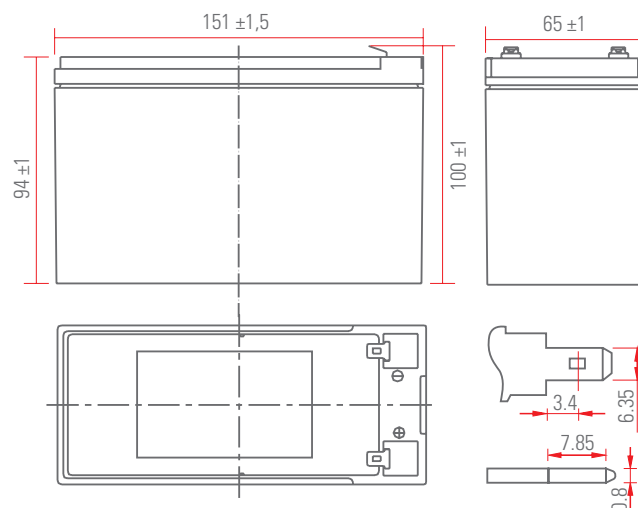

Behaviour charts

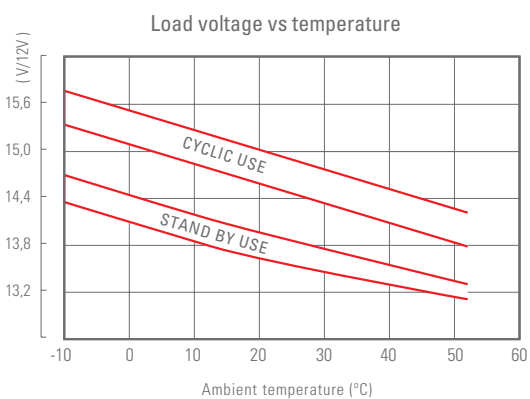
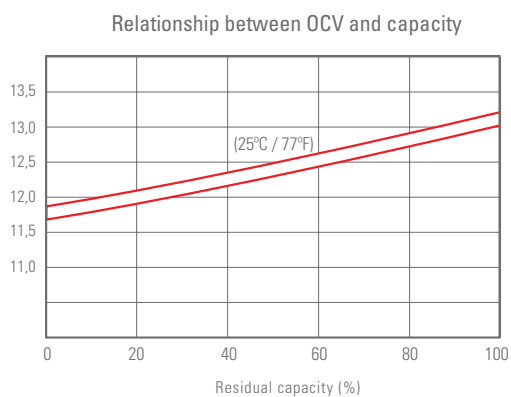
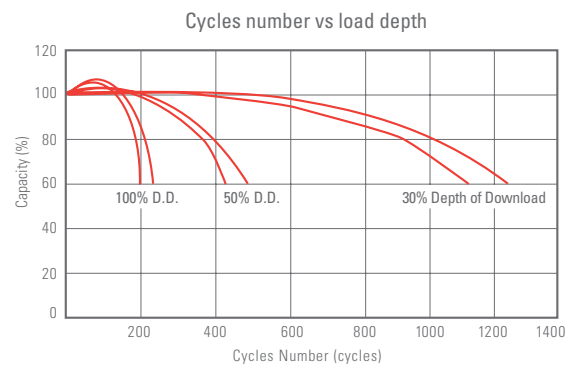
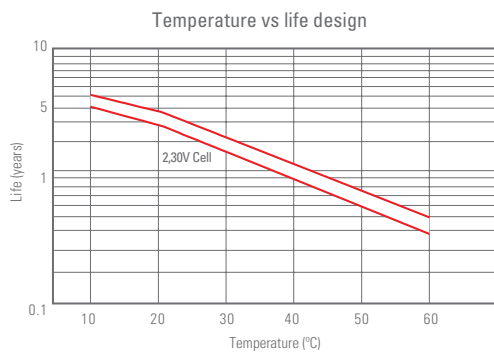
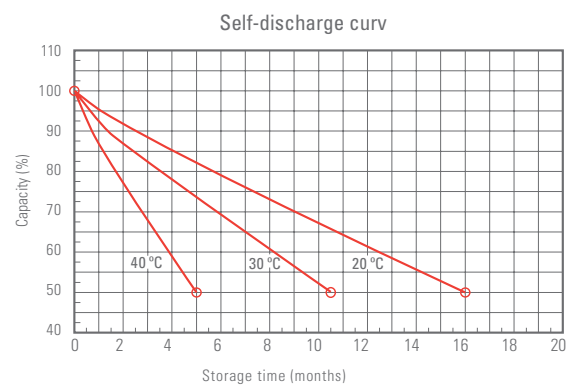
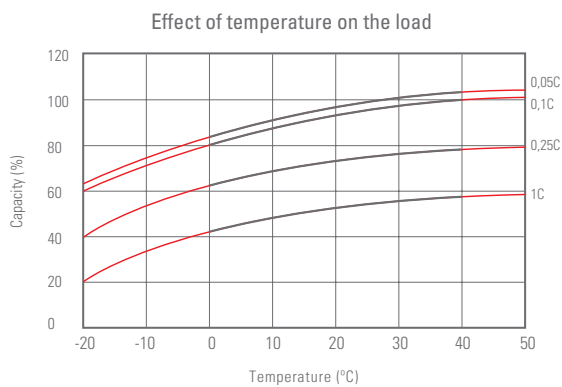
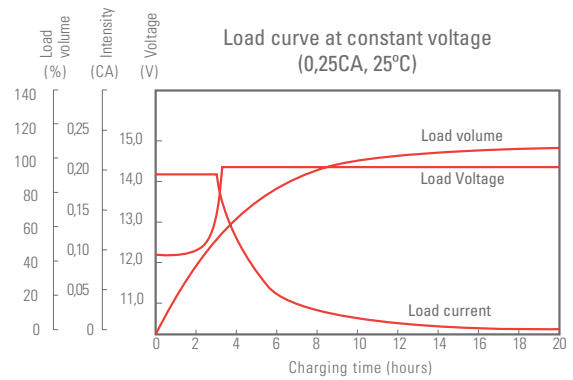
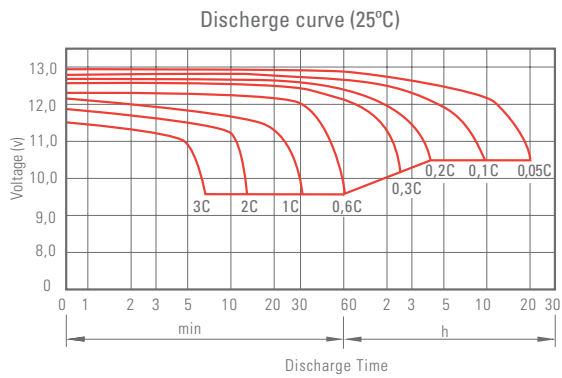

Technical specifications

MODEL		UBT 12/7
Nominal voltage (V)		12
Number of cells		6
Rated capacity at 25°C	20 hours	7,0 Ah (0,35 A, 10,5 V)
	10 hours	6,5 Ah (0,65 A, 10,5 V)
	5 hours	6 Ah (1,2 A, 10,5 V)
	1 hour	4,2 Ah (4,59 A, 9,6 V)
Internal resistance		≤25 mΩ ⁽¹⁾
Self-discharge		3% ⁽²⁾
Operating temperature range	Discharge	-15°C ÷ +50°C
	Charge	-10°C ÷ +50°C
	Storage	-20°C ÷ +50°C
Maximum discharge current		105 A (5s)
Dimensions	Depth	151 mm ±1 mm
	Width	65 mm ±1 mm
	Height	94 mm ±1 mm
Overall dimensions (with connectors)	Height	100 mm ±1 mm
Weight		2,1 Kg
CODE		013BS000001

(1) Fully charged battery at 25°C

(2) Reduction of capacity per month at 20°C (average)

Information subject to change without notice.

Constant discharge current (25°C)

Cut-off voltage per cell (V/cell)	5 min	10 min	15 min	30 min	60 min	2 h	3 h	4 h	5 h	10 h	20 h
9.60 V	26.7	16.9	13.2	7.46	4.59	2.51	1.74	1.44	1.22	0.66	0.36
9.90 V	25.9	16.4	12.9	7.31	4.52	2.49	1.72	1.43	1.21	0.66	0.35
10.2 V	24.9	15.8	12.4	7.08	4.40	2.47	1.71	1.42	1.21	0.66	0.35
10.5 V	23.8	15.1	12.0	6.91	4.31	2.43	1.70	1.41	1.20	0.65	0.35
10.8 V	22.5	14.2	11.4	6.66	4.18	2.37	1.65	1.36	1.16	0.64	0.34

Constant discharge power (25°C)

Cut-off voltage per cell (V/cell)	5 min	10 min	15 min	30 min	60 min	2 h	3 h	4 h	5 h	10 h	20 h
9.60 V	298	191	151	85.4	53.1	29.3	20.6	17.1	14.6	7.95	4.26
9.90 V	289	185	147	83.7	52.3	29.2	20.5	17.0	14.5	7.92	4.25
10.2 V	278	178	142	81.2	51.0	28.9	20.3	16.9	14.4	7.88	4.23
10.5 V	266	170	137	79.2	50.0	28.5	20.2	16.8	14.3	7.84	4.20
10.8 V	251	161	130	76.3	48.4	27.8	19.6	16.3	14.9	7.68	4.12

The data shown above relates to average values obtained after 3 charge/discharge cycles, not minimum values



@salicru_en



www.linkedin.com/company/salicruen/